

PRODUCT OVERVIEW



T-CLASS WATER-COOLED CHILLERS



SMARTD
GLOBAL #1 IN OIL-FREE CHILLERS

T-Class Water-Cooled Chillers

Smardt's T-Class of chillers utilize Smardt's oil-free chiller technology with Turbocor's TTS compressors using R134a refrigerant. T-Class Water-Cooled Chillers are available from 45 to 1600 TR (160 to 5625 kW) and can be supplied in multiple configurations, which Smardt can customize per the requirements of your application.



A Smardt T-Class water-cooled chiller equipped with two Turbocor TTS compressors

T-Class Chillers

Smardt has brought its extensive experience in oil-free chiller development, sales and service into designing the T-Class — a range of water-cooled chillers that deliver the highest level of reliability, outstanding efficiency and the lowest total cost of ownership.

T-Class chillers offer valuable benefits to owners and operators, such as ease of installation, simple streamlined operation and maintenance, and lower lifetime operating and maintenance costs. These advantages are the hallmark of Smardt chillers.

Your requirements for capacity, configuration, and turndown performance will help your Smardt representative assist with determining the best product fit for your project.

Oil-Free Operation

Smardt oil-free centrifugal chillers use magnetic bearings and a variable-speed drive to deliver IPLV efficiencies that far surpass those of conventional oil-lubricated centrifugal, reciprocating, scroll and screw chillers.

Smardt utilizes totally oil-free Turbocor compressor technology, achieving the highest part-load efficiencies for our chillers and chilled water systems (including water-, air- and evaporatively-cooled applications).

Proprietary magnetic bearings replace conventional oil-lubricated bearings. This eliminates the high friction losses, mechanical wear, and the higher-maintenance oil management systems that are inherent with conventional compressor designs.

Turbocor's primary moving part (the rotor shaft and impellers) is levitated during rotation by a digitally controlled magnetic bearing system. Position sensors at each magnetic bearing provide real-time feedback to the bearing control system, 120 times each revolution, ensuring constantly centered rotation.

The result is oil-free operation that delivers significant chiller energy savings compared with standard chillers, and provides an extended service life without the efficiency decrease seen in oil-based systems.

Global Number One

Smardt is the industry leader in oil-free centrifugal chillers. Smardt pioneered oil-free centrifugal compressor technology to provide plant owners and operators a line of chillers that broke through industry norms of lifetime performance, energy conservation (reducing operating expenses), streamlined maintenance, and ease of operation.

Since our first oil-free centrifugal chiller in 2002, more than 10,000 Smardt chillers, ranging from 60 TR up to 3200 TR, are now saving money, energy and CO₂ emissions across the globe.

T-Class Water-Cooled Chillers

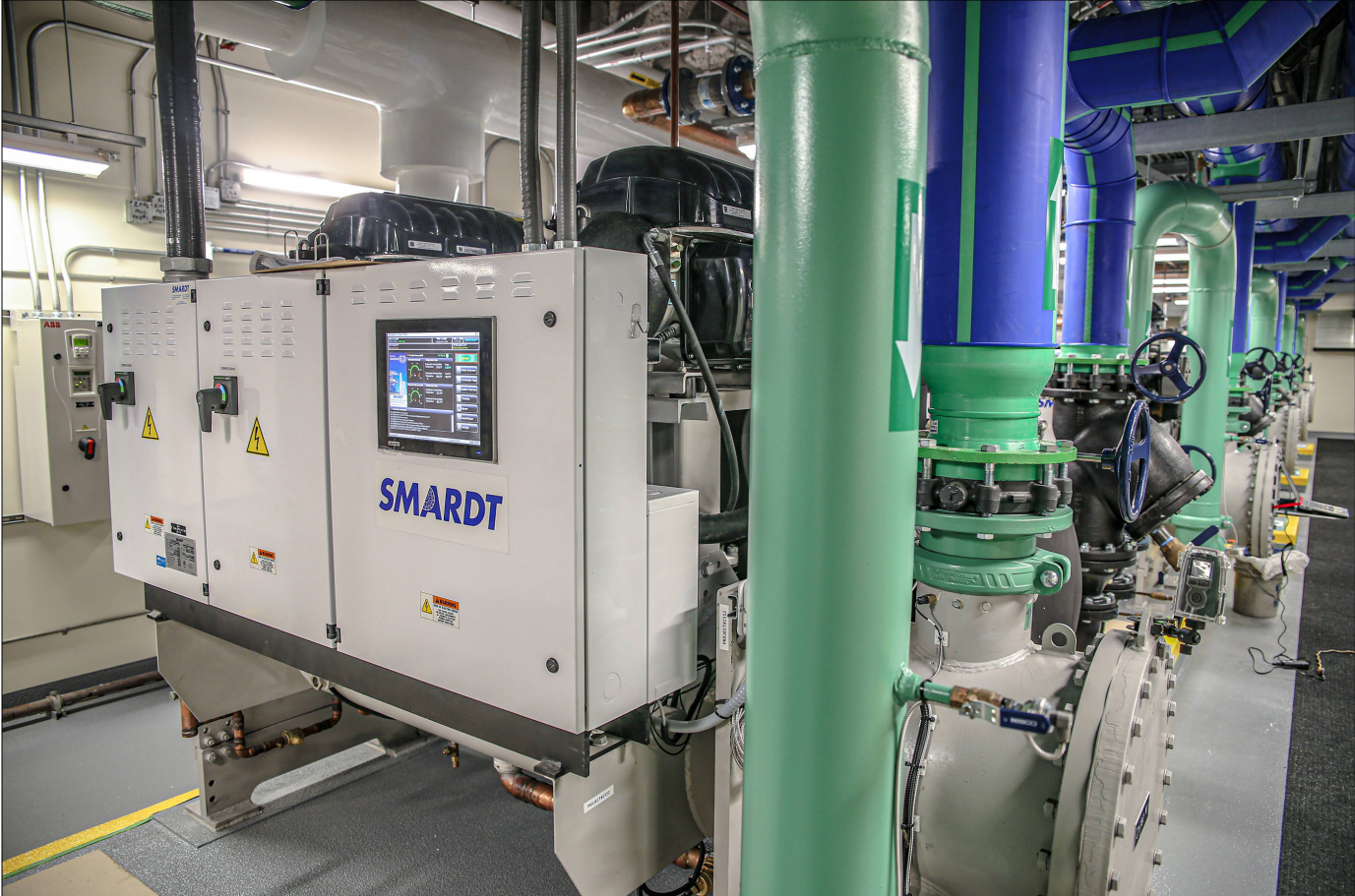

T-Class Water-Cooled Chillers

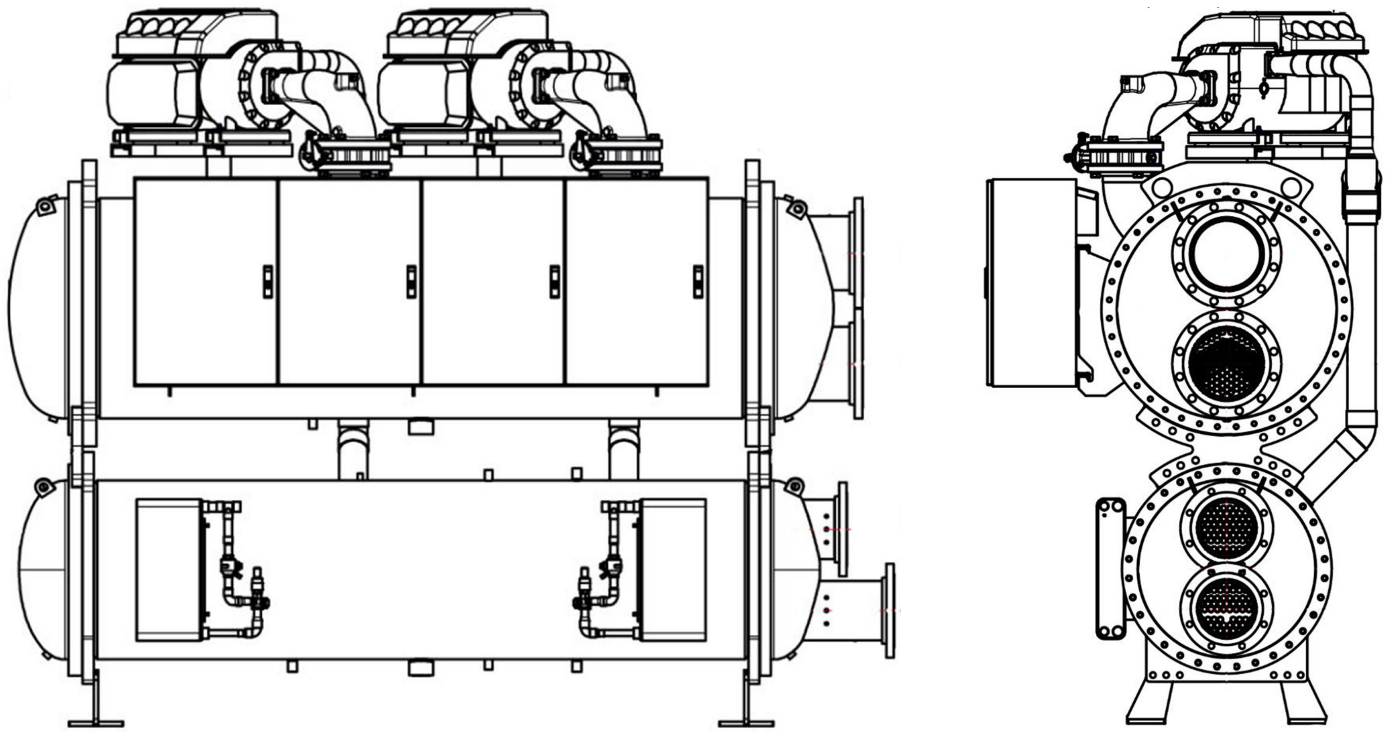

Side and front views of a Smardt T-Class water-cooled chiller customized in a stacked (narrow) configuration to fit a smaller footprint within a plant room

Turbocor TTS Compressor

T-Class chillers can be equipped with up to eight Turbocor TTS oil-free compressors. VFDs are built-in, and drives are internal to the machine. These oil-free compressors have low-sound output and use R134a or R513A refrigerants.* For R513A chiller solutions, please see Smardt's G-Class chillers.

Extended Service Life

The T-Class chiller is designed for a service life of 25 years.



TTS Compressor

Multiple Configurations

Smardt can configure your T-Class chiller to fit any footprint or height restriction, with multiple barrel configurations available (see illustration on page 5).

Chiller Options

Options for Smardt's T-Class chillers include our integrated pump packages, economizer, Smardt Lift, and Smardt Restart.

Smardt Lift enables chiller operation at full load with enhanced efficiencies when supplying chilled water at temperatures that are close to the ambient temperature. This is extremely beneficial in both high temperature chilled water applications or in seasonal operation when the ambient temperature is similar to the design chilled water conditions.

Smardt Restart ensures that in the event of a power failure, your Smardt chiller is back on line as quickly as 20 seconds. Chilled water supply for critical applications is not impacted by intermittent power loss, eliminating the need for additional thermal storage. The start-up mode includes additional motor and surge protection.

Applications

Energy conscious plant owners and operators want optimized performance with savings over the life of the chiller. Smardt's T-Class chillers support critical-load applications in a variety of markets, including commercial, data center, pharmaceutical, hospital, higher education, district cooling, hotels, malls, and manufacturing.

*The Danfoss Turbocor TTS compressor can use R134a or R513A refrigerants. A Smardt T-Class chiller using R513A effectively becomes a G-class chiller.

T-Class Water-Cooled Chillers

Smardt Chiller Barrel Configuration Options

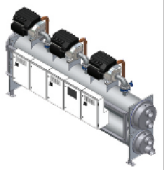
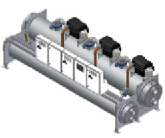
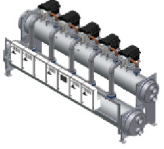
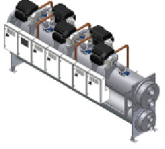
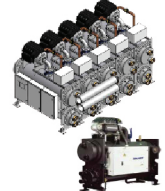
Standard Configuration	Configuration Options for Dimensional Considerations				Additional Options for Special Requirements
Narrow  1-8 compressors <ul style="list-style-type: none"> Stacked orientation Slim design 	Side-by-Side  1-8 compressors <ul style="list-style-type: none"> Barrels beside each other For short and wide layouts Panels mounted above condenser barrel 	Low Profile  1-8 compressors <ul style="list-style-type: none"> Condenser on top For height-restrictive projects 	Fat Max  1-8 compressors <ul style="list-style-type: none"> Larger-diameter barrels Staggered compressor orientation Shorter length 	Compact - Modular  1-8 compressor <ul style="list-style-type: none"> For tight fits Can be modular Dimensioned to fit through elevators and doors 	

Plant Room Access Options

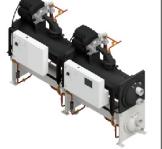
Configuration Options for Plant Room Access Considerations	
Knocked-Down Kit  1-8 compressors <ul style="list-style-type: none"> Fully-built chiller tested at factory Disassembly of components: compressors, control panel, and even complete disassembly if needed 	Split Barrel  1-8 compressors <ul style="list-style-type: none"> Ideal for applications with limited plant room area

Smardt T-Class Water-Cooled Chillers offer barrel configuration flexibility for applications with restricted footprints or access challenges

Highlights

- Class leading part-load efficiencies, achieving optimum IPLV in total capacity range.
- Typically smaller footprint than chillers of comparable capacity.
- Responsive chilled water control under all conditions.
- Inbuilt redundancy with multiple compressors.
- Designed for ease of maintenance and serviceability, featuring field-serviceable compressors.
- Smardt quality, acceptance tested and pre-commissioned prior to delivery ensuring trouble-free commissioning and start-up on every project.

T-Class Water-Cooled Chillers

Smardt's T-Class Water-Cooled Chillers with full-load capacities of units with R 134a refrigerant, range from 45 to 1600 TR (160 to 5625 kW)

Representative Models

Smardt can customize your T-Class chiller to meet your project's needs and specifications. The models included in this capacity chart are considered representative of the T-Class, but selection is not limited to these specific models. Your Smardt representative can provide capacity data for your project.

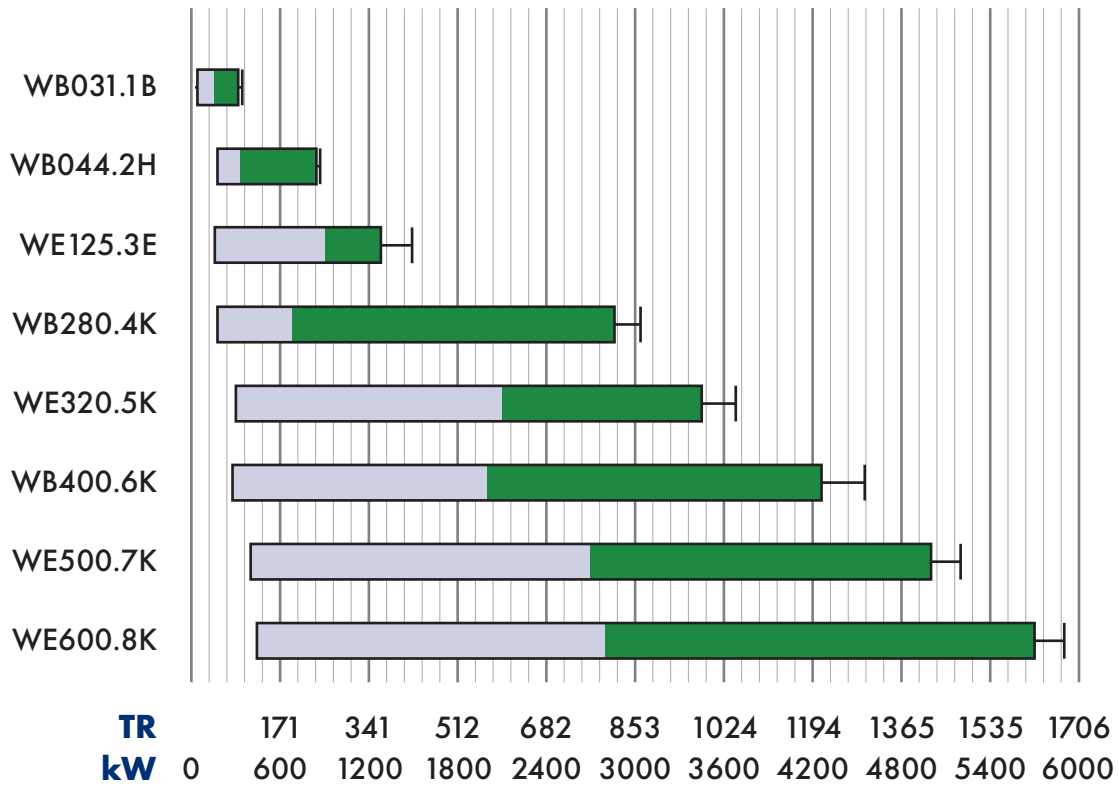

Cooling Capacity TR (kW)



Note: Available cooling capacity will vary with operating conditions and chiller configuration. Capacities shown are based on standard AHRI conditions.

T-Class Water-Cooled Chillers

Model Number Nomenclature

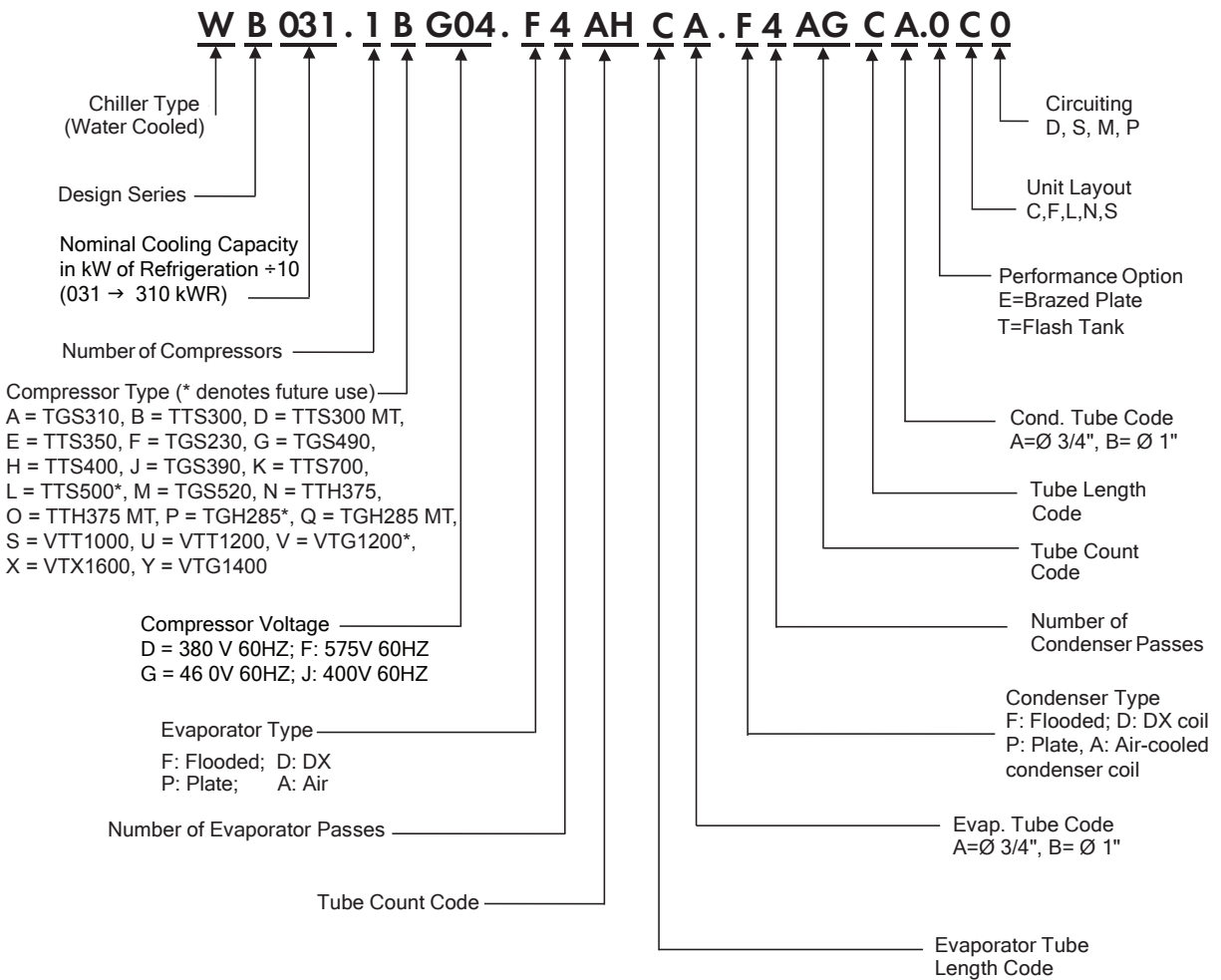

Global reach, single focus

Smardt is both the pioneer and world-leader in oil-free centrifugal chillers, with production facilities in Canada (Montreal area), Australia (Melbourne area), United States (Plattsburgh, New York), Germany (Stuttgart area), and China (Guangzhou and Nanjing).

Smardt service networks extend across the globe to monitor and support the world's largest installed base of oil-free high-efficiency chillers, with more than 10000 chillers installed globally.



AMERICAS

Canada

Smardt Chiller Group Inc.
1800 Trans-Canada Highway
Dorval, Quebec H9P1H7
T +1 514 426 8989
E sales.ca@smardt.com

USA

Smardt Chillers Inc.
22 Colorado Street, Bldg 2815
Plattsburgh, NY 12903
T +1 518 324 5741
E sales.us@smardt.com

Brazil

Mecalor Solutions (licensed partner)
Rua da Bandeira, 219-Novo Mundo Park
São Paulo, Brazil
T +55 11 2188 1700
E sales@mecalor.com

ASIA PACIFIC

Australia

Smardt Chiller Pty Ltd
144 Colchester Road
Bayswater North VIC 3153
T +61 3 9761 7905
E sales.au@smardt.com

China

Guangzhou Smardt Chillers Manufacturing Co. Ltd
Mei Xing Industrial Park
No. 30 Dong Zhong Road ETDD
Guangzhou
T +86 20 8205 7161
E sales.cn@smardt.com

Guangzhou Smardt Chillers Manufacturing Co. Ltd, Nanjing Branch No. 2,
Hengxiang Road, Qixia Economic and Technological Development Zone, Nanjing, China
T +86 25 8532 6977
E sales.cn@smardt.com

TICA Smardt Hong Kong Ltd
11/F, The Bedford, 91-93 Bedford Road
Tai Kok Tsui, Kowloon, Hong Kong
T +852 2772 8448
E hk.info@smardt.com

Singapore

Smardt Chillers Pte Ltd
438A Alexandra Road #08-11
Alexandra Technopark 119967
T +65 6273 1120
E sales.as@smardt.com

EMEA

Germany

Smardt-OPK Chillers AG
Bahnhofstraße 74
D73240 Wendlingen
T +49 7024 79429 0
E sales.eu@smardt.com
www.opk.de

United Kingdom

Smardt Chiller UK
10A Burrell Way, Theford,
Norfolk IP24 3RW
T +44 1842 824830
E sales.uk@smardt.com

Follow us.



www.smardt.com

Smardt has exercised its best efforts to ensure that the information contained in this document is correct at time of printing. However, no warranty, reliability or accuracy is given with respect to the information contained herein, and Smardt is not and shall not be responsible for any error or omission, or liable for the correctness or suitability of the information given. All brand names and product names used in this manual are trademarks, registered trademarks, or trade names of their respective holders.
© 2022, Smardt Chiller Group Inc. All rights reserved. 03/2022